

## A COMPARATIVE STUDY OF TWO TYPES OF DTC WITH APPLICATION OF ARTIFICIAL INTELLIGENCE: FUZZY LOGIC AND NEURON NETWORK ON THE PERFORMANCE OF A MULTI-LEVEL INVERTER FED INDUCTION MACHINE

**BENAOUDA O & BENDIABDELLAH A**

Laboratoire De Development Des Entrainements Electrique (LDEE), Diagnostic group,  
 Faculty Electrical Engineering, Electronics Department, University of Science and Technology of Oran,  
 Oran, Al M'naouar, Algeria

### ABSTRACT

We present in this paper the simulation results of the speed control of a 3 levels inverter fed induction machine controlled by the Direct Torque Control with application of artificial intelligence techniques both the fuzzy logic (DTC\_FL) and the neural network (DTC\_NN). A comparative study of these two techniques is also presented to illustrate the merits of each of the techniques on the performance of the 3-levels inverter-/induction machine set.

**KEYWORDS:** Induction Machine, 3-Levels Inverter, Direct Torque Control (DTC), DTC\_FL, DTC\_NN

### INTRODUCTION

The technique of direct torque control (DTC) introduced in 1985 by Takahashi [1, 2] is a seductive approach due to its effectiveness on one hand and its simplicity of implementation on the other hand. Several works have enabled rigorous modeling approach [2, 3], that is based on a pulse width modulation feeding and on the decoupling between the flux and torque of the motor by the magnetic field orientation [4]. The techniques of fuzzy logic and artificial neural network will also be introduced and used for performance improvement of classical DTC. The model is then simulated on a Matlab/Simulink environment.

### BASIC PRINCIPLE OF DTC TECHNIQUE

The voltage expressions of the machine used in the stator referential is given as:

$$\left\{ \begin{array}{l} \bar{V}_s = R_s \bar{I}_s + \frac{d\bar{\phi}_s}{dt} \end{array} \right. \quad (1)$$

$$\left\{ \begin{array}{l} \bar{V}_r = 0 = R_r \bar{I}_r + \frac{d\bar{\phi}_r}{dt} - j\omega \bar{\phi}_r \end{array} \right. \quad (2)$$

The rotor current expression is written as:

$$\bar{I}_r = \frac{1}{\sigma} \left( \frac{\bar{\phi}_r}{L_r} \bar{I}_s - \frac{L_m}{L_s L_r} \bar{\phi}_s \right)$$

$$\text{With } \sigma = 1 - \frac{L_m^2}{L_r L_s}$$

Substituting (2) in (1) becomes:

$$\left\{ \begin{array}{l} \bar{V}_s = R_s \bar{I}_s + \frac{d\bar{\phi}_s}{dt} \\ \frac{d\bar{\phi}_r}{dt} + \left( \frac{1}{\sigma\tau_r} - j\omega \right) \bar{\phi}_r = \frac{L_m}{L_r} \frac{1}{\sigma\tau_r} \bar{\phi}_s \end{array} \right.$$

The voltage vector  $\bar{V}_s$  supplied by the three-phase voltage inverter source is shown in Figure 1 by using 3 Boolean control variables  $S_j$  ( $j = a, b, c$ ) such that:

- $S_j$  ( $j = a, b, c$ ) = 1: High Switch ON and Low Switch OFF.
- $S_j$  ( $j = a, b, c$ ) = 0: High Switch OFF and Low Switch ON.

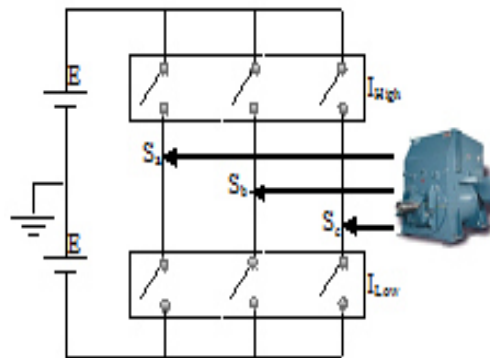

**I<sub>high</sub>: High Switch I<sub>low</sub>: Low Switch**

**Figure 1: Voltage Inverter Fed Induction Machine**

The voltage vector  $\bar{V}_s$  can be written as:

$$V_s = \sqrt{2/3} U_0 [S_a + S_b e^{\frac{j2\pi}{3}} + S_c e^{\frac{j4\pi}{3}}] \quad (3)$$

Combinations of the 3 values ( $S_a, S_b, S_c$ ) are used to generate 8 positions of the vector  $\bar{V}_s$ , where 2 zero vectors correspond to: ( $S_a, S_b, S_c$ ) = [(000) or (111)] as shown in Figure 1.

## FLUX AND TORQUE CONTROL

From (1), it can be written that:

$$\varphi_s = \varphi_{s0} + V_s t - R_s \int_0^t I_s dt \quad (4)$$

With the assumption that the stator resistance  $R_s$  remains constant, and the term ( $R_s I_s$ ) to be negligible compared

to the voltage  $V_s$ . In a time interval  $T_e$ , the end of the vector  $\phi_s$  moves on a straight line whose direction is given by the vector  $V_s$ , Figure 2. By choosing the correct sequence of vectors  $V_s$  on successive time intervals of duration  $T_e$ , one can follow at the end of the vector, the desired trajectory. To achieve this goal, the corrector used for the DTC is a two levels hysteresis corrector. With this type of corrector, one can easily hold the end of the flux vector in an almost circular shape.

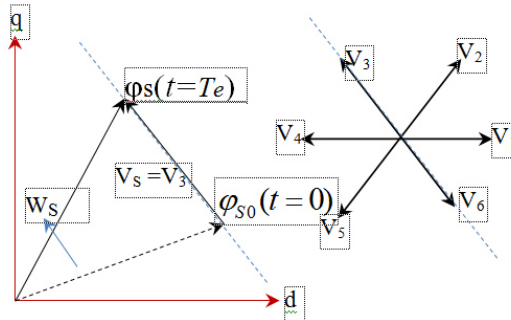

Figure 2: Evolution of the End of the Vector  $\phi_s$

The variations of the electromagnetic torque can be controlled only from the rotational speed of the flux vector. Table 1 shows the evolution of both flux and torque magnitudes for each of the four vectors  $V_{i+1}$ ,  $V_{i+2}$ ,  $V_{i-1}$ ,  $V_{i-2}$ , which can be applied in the zone  $Z_i$ . The voltage vectors to be applied depend on the region where the flux vector is located. The parameters  $Z_1, Z_2, Z_3, Z_4, Z_5, Z_6$  represent the six possible zones of operation.

Table 1: Evolution of the Flux and Torque Variables as a Function of the Vector  $V_k$  Applied in the Zone  $Z_i$

Vecteur $V_k$	$V_{i+1}$	$V_{i+2}$	$V_{i-1}$	$V_{i-2}$
$\phi_s$				
$C_{em}$				

$$k = (i-1, i-2, i+1, i+2)$$

**SELECTION OF THE VOLTAGE VECTOR  $V_s$**

The choice of the vector  $V_s$  depends on the location of the  $\phi_s$  in the referential (S), on the desired variation of the module  $\phi_s$ , on the desired variation torque and on the direction of rotation of  $\phi_s$ . The evolution space of  $\phi_s$  in (S) is divided into twelve space areas  $i$ , with  $i = [1, 12]$ , Figure 3.

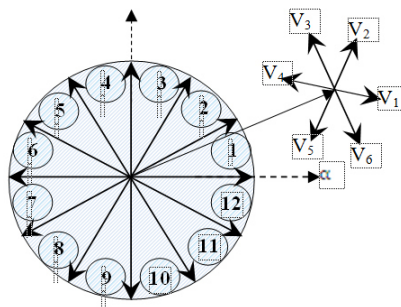

Figure 3: Representation of 12 Divisions of the Complex Plane

The voltage vectors associated with switching states are:

**Table 2: Voltage Vectors Associated with Switching States of 3-Level Inverter**

Vecteur	Symbole
ZVV	(P P P),(O O O),(N N N)
MVV	(P O N),(O P N),(N P O),(N O P),(O N P),(O N P)
LVV	(P N N),(P P N),(N P N),(N P P),(N N P),(P N P)
USVV	(P O O),(P P O),(O P O),(O P P),(O O P),(P O P)
LSVV	(O N N),(O O N),(N O N),(N O O),(N N O),(O N O)

The table shows that there are 27 states of the inverter switching. Under these conditions, there will be 19 different vector voltages.

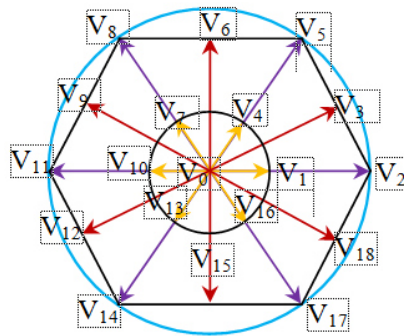

**Figure 4: Voltage Vectors in the Hexagonal Plane**

Figure 4 shows that the voltage vectors are classified into four groups according to their modules. These are:

- ZVV group, the zero voltage vector  $V_0$ .
- SVV group, the small voltage vectors  $V_1, V_4, V_7, V_{10}, V_{13}, V_{16}$ .
- MVV group, the mean voltage vectors  $V_3, V_6, V_9, V_{12}, V_{15}, V_{18}$ .
- LVV group, the large voltage vectors.  $V_2, V_5, V_8, V_{11}, V_{14}, V_{17}$

## THE ELABORATION OF CORRECTORS

### 3-Level Flux Corrector

The purpose of the flux corrector is to maintain the end of the vector flux  $\phi_s$  in a circular mesh [1]. The output of the hysteresis corrector, as represented by a variable boolienne indicates directly whether the amplitude of the flux should be increased or decreased ( $C_{flx}=-1$ ,  $C_{flx}=0$ ,  $C_{flx}=+1$ ).

### 5-Level Torque Corrector

The torque corrector has as objective to maintain the torque within the limits  $|C_{ref} - C_{em}| \leq \Delta C$ , with  $C_{ref}$  the torque reference and  $\Delta C$  the hysteresis band of the corrector couple function. However a difference with the flux control is that the torque can be positive or negative depending on the rotation direction of the machine. To improve torque control, the torque error  $\Delta C$  is associated with five regions defined by the following constraints:

$$(\epsilon_C < \Delta C_{\min 2})$$

$$(\Delta C_{\min 2} \leq \epsilon_C \leq \Delta C_{\min 1})$$

$$(\Delta C_{\min 1} \leq \epsilon_C \leq \Delta C_{\max 1})$$

(5)

$$(\Delta C_{\max 1} \leq \epsilon_C \leq \Delta C_{\max 2})$$

$$(\epsilon_C > \Delta C_{\max 2})$$

The control torque is provided by a hysteresis comparator with five levels or two upper bands ( $\Delta C_{\max 1}, \Delta C_{\max 2}$ ) and two lower bands ( $\Delta C_{\min 1}, \Delta C_{\min 2}$ ) as illustrated in Figure 5, and also its outputs which are ( $ccpl=-1, ccpl=-2, ccpl=0, ccpl=+1, ccpl=+2$ ).

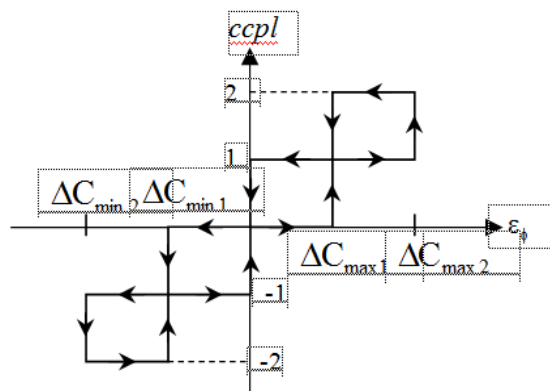

Figure 5: 5-Level Torque Corrector

## BASED NEURAL NETWORK DTC

### Based Principle of Neural Network

Neural networks are a set of nonlinear functions to build, by learning, a large family of models and nonlinear correctors [5]. From a mathematical point of view, the artificial neural can be represented as follows, Figure 6.

### Interpretation Mathematique D'un Reseau De Neurone

From mathematical point of view, the neurone formel can be represented in the following manner, figure 6.

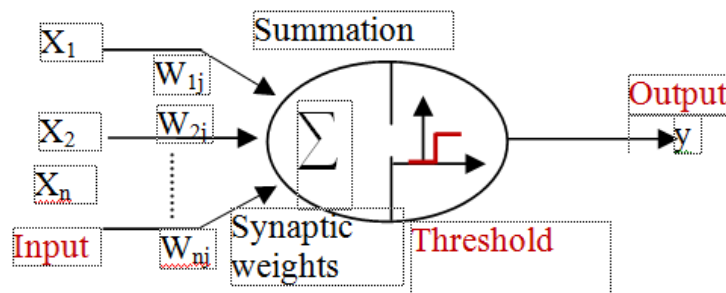

Figure 6: An (RN) Multilayer Structure

## Direct Torque Neural Control (DTNC)

The application of neural network technique in the machine control is simple and has enabled the resolution of several issues related to the control of these systems.

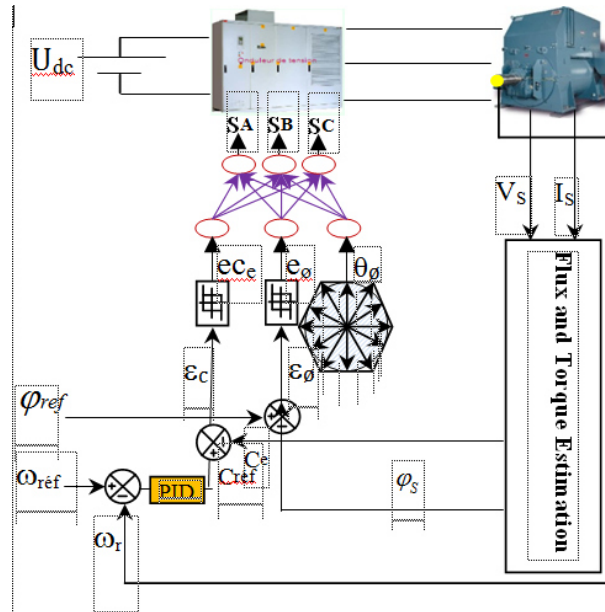

Figure 7: DTNC\_12S Control of an Induction Machine with a 5-Level Torque Corrector and 12 Sectors Controleur Neuronal

In this neural network is used 12 neurons in the hidden layer and for the activation function we chose the log- sigmoid function.

## BASED FUZZY LOGIC DTC

### Based Principle of Fuzzy Logic

Fuzzy logic is a method of treatment of uncertainties and is intended for the representation of imprecise knowledge. It is based on current linguistic terms such as: small, large, medium etc. It allows intermediate values between right and wrong and admits overlap between them [6].

### Variable De Commande

Control rules can be expressed in terms of input variables and outputs as follows:  $R_i$ : if  $\epsilon_C$  is  $A_i$  and  $\epsilon_{\phi_s}$  is  $B_i$ , and  $\theta_s$  is  $C_i$  then  $n$  is  $N_i$  where  $A_i$ ,  $B_i$ ,  $N_i$  are the fuzzy sets [7].

The treatment of these rules shall be made by the method of the least Mamdani expressed by:

$$\mu_{R_i}(n) = \min(\alpha_i, N_i)$$

Avec:

$$\alpha_i = \min(\mu_{A_i}(\epsilon_C), \mu_{B_i}(\epsilon_{\phi}), \mu_{C_i}(\theta_s))$$

Switching Table for (DTC\_LF)

The following tables are similar.

The variables errors: " $\epsilon_\phi$ " flux error, " $\epsilon_C$ " torque error and " $\theta_s$ " flux position.

Table 3

$\theta_1$						$\theta_2$					
$e_\phi$ \ $e_C$	NL	NS	ZE	PS	PL	$e_\phi$ \ $e_C$	NL	NS	ZE	PS	PL
P	V <sub>17</sub>	V <sub>18</sub>	V <sub>0</sub>	V <sub>3</sub>	V <sub>5</sub>	P	V <sub>2</sub>	V <sub>18</sub>	V <sub>0</sub>	V <sub>6</sub>	V <sub>5</sub>
Z	V <sub>13</sub>	V <sub>0</sub>	V <sub>0</sub>	V <sub>4</sub>	V <sub>4</sub>	Z	V <sub>16</sub>	V <sub>0</sub>	V <sub>0</sub>	V <sub>7</sub>	V <sub>6</sub>
N	V <sub>14</sub>	V <sub>15</sub>	V <sub>0</sub>	V <sub>6</sub>	V <sub>8</sub>	N	V <sub>17</sub>	V <sub>15</sub>	V <sub>0</sub>	V <sub>9</sub>	V <sub>8</sub>

$\theta_3$						$\theta_4$					
$e_\phi$ \ $e_C$	NL	NS	ZE	PS	PL	$e_\phi$ \ $e_C$	NL	NS	ZE	PS	PL
P	V <sub>2</sub>	V <sub>3</sub>	V <sub>0</sub>	V <sub>6</sub>	V <sub>8</sub>	P	V <sub>5</sub>	V <sub>3</sub>	V <sub>0</sub>	V <sub>9</sub>	V <sub>8</sub>
Z	V <sub>16</sub>	V <sub>0</sub>	V <sub>0</sub>	V <sub>7</sub>	V <sub>7</sub>	Z	V <sub>1</sub>	V <sub>0</sub>	V <sub>0</sub>	V <sub>10</sub>	V <sub>7</sub>
N	V <sub>17</sub>	V <sub>18</sub>	V <sub>0</sub>	V <sub>9</sub>	V <sub>11</sub>	N	V <sub>0</sub>	V <sub>18</sub>	V <sub>0</sub>	V <sub>12</sub>	V <sub>11</sub>

$\theta_5$						$\theta_6$					
$e_\phi$ \ $e_C$	NL	NS	ZE	PS	PL	$e_\phi$ \ $e_C$	NL	NS	ZE	PS	PL
P	V <sub>5</sub>	V <sub>6</sub>	V <sub>0</sub>	V <sub>9</sub>	V <sub>11</sub>	P	V <sub>8</sub>	V <sub>6</sub>	V <sub>0</sub>	V <sub>12</sub>	V <sub>11</sub>
Z	V <sub>1</sub>	V <sub>0</sub>	V <sub>0</sub>	V <sub>10</sub>	V <sub>10</sub>	Z	V <sub>4</sub>	V <sub>0</sub>	V <sub>0</sub>	V <sub>13</sub>	V <sub>11</sub>
N	V <sub>2</sub>	V <sub>3</sub>	V <sub>0</sub>	V <sub>12</sub>	V <sub>14</sub>	N	V <sub>5</sub>	V <sub>3</sub>	V <sub>0</sub>	V <sub>15</sub>	V <sub>14</sub>

$\theta_7$						$\theta_8$					
$e_\phi$ \ $e_C$	NL	NS	ZE	PS	PL	$e_\phi$ \ $e_C$	NL	NS	ZE	PS	PL
P	V <sub>14</sub>	V <sub>15</sub>	V <sub>0</sub>	V <sub>18</sub>	V <sub>2</sub>	P	V <sub>11</sub>	V <sub>9</sub>	V <sub>0</sub>	V <sub>15</sub>	V <sub>14</sub>
Z	V <sub>10</sub>	V <sub>0</sub>	V <sub>0</sub>	V <sub>1</sub>	V <sub>1</sub>	Z	V <sub>7</sub>	V <sub>0</sub>	V <sub>0</sub>	V <sub>16</sub>	V <sub>13</sub>
N	V <sub>11</sub>	V <sub>12</sub>	V <sub>0</sub>	V <sub>3</sub>	V <sub>5</sub>	N	V <sub>8</sub>	V <sub>6</sub>	V <sub>0</sub>	V <sub>18</sub>	V <sub>17</sub>

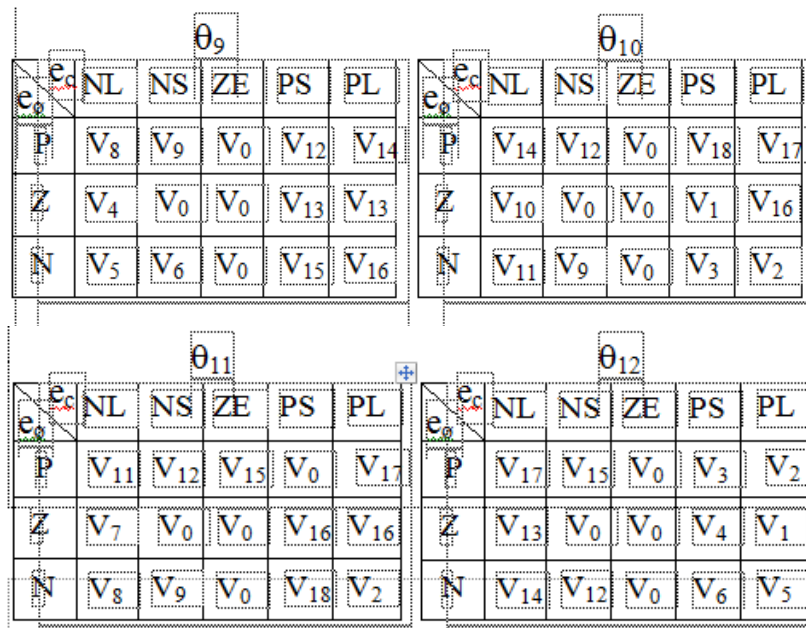

## SIMULATION RESULTS

The simulation results are obtained for a 3-level voltage inverter fed 1, 5kw induction machine. Figure 8, Figure 9, and Figure 10 below are obtained for the case of neural network technique applied to the DTC (DTNC\_12S) with a switching table: 5-level torque corrector and 3-level stator flux.

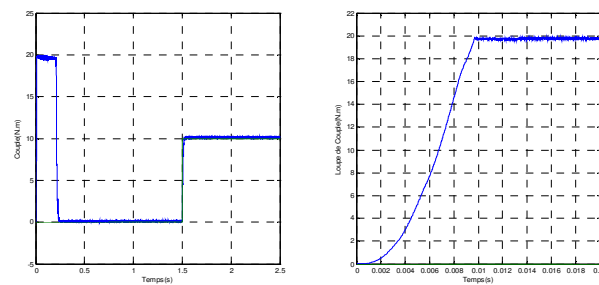

Figure 8: The Reference Change and Torque Evolutions a Function of Time, Case: (DTNC)

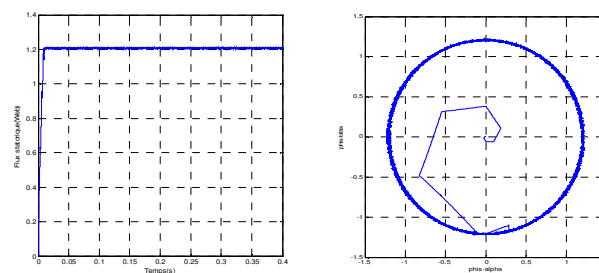

Figure 9: Flux Evolution in Terms of Time for a Reference Value:  $\Phi_{s0}=1.207$ , Case: (DTNC)



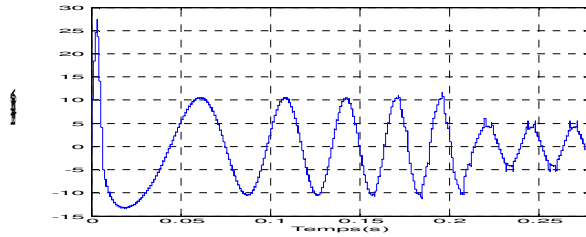

Figure 10: Stator Current of Phase  $\alpha$ , Case: (DTNC)

Figure 11, Figure 12, and Figure 13 below are obtained for the case of fuzzy logic technique applied to the DTC (DTNC\_LF) with a switching table: 5-level torque corrector and 3-level stator flux.

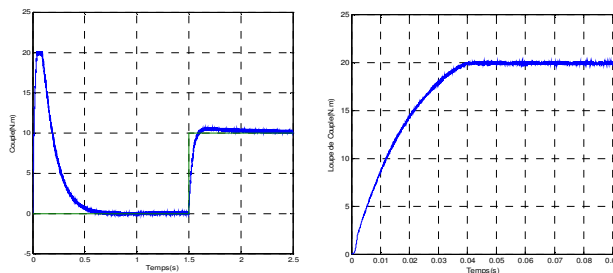

Figure 11: The Reference Change and Torque Evolution as a Function of Time, Case: (DTC\_LF)

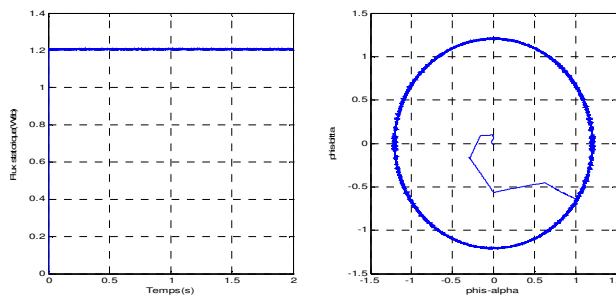

Figure 12: Flux Evolution In Terms Of Time For A Reference Value:  $\Phi_{s0}=1.207wb$ , Case: (DTC\_LF)

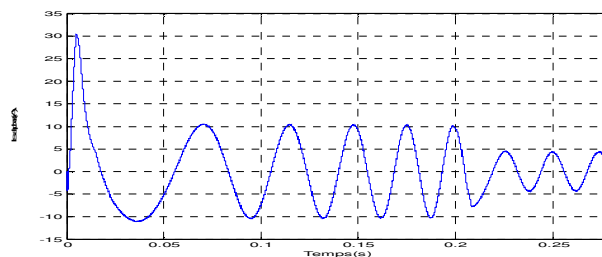

Figure 13: Stator Current of Phase  $\alpha$ , Case: (DTC\_LF)

### COMPARATIVE STUDY BETWEEN THE TWO CONTROLS METHODS DTNC AND DTCLF

Simulation results show that the performance obtained by DTCLF control is significantly better than those obtained by DTNC control. It is interesting to note in Figure 11 a dynamic torque response with a slow transient. The stator flux in DTCLF, Figure 12, has a very good response and we can see a slight excess in comparison to DTNC,

see Figure 9. Figure 12 also shows a fast transient of stator flux module in a perfectly circular with no ripples in the steady state, and this is reflected in the torque and flux quantities.

## CONCLUSIONS

### The Benefits of DTNC\_12S Control are

- The torque is well controlled.
- The flux and torque follow perfectly their references.
- The stator current is sinusoidal.

### The DTNC Has Three Major Problems

- The flux is established slowly.
- The switching frequency is variable around 3kHz.
- The problem of the choice of the learning.

### The Benefits of DTC\_LF Command are

- The flux and torque are well controlled
- The constant switching frequency around 4kHz

### The DTC\_LF Presents a Major Problem

- The switching frequency can be a little high

## REFERENCES

1. Takahashi and T. Noguchi, "A new quick response and high efficiency control strategy of induction motor", *IEEE Trans. Ind. Electron.*, IE-22, Sept./Oct. 1986.
2. Takahashi and S. Asakawa, "Ultra-wide speed control of induction motor covered 10A6 range", *IEEE Trans. Ind. Applicat.*, IA-25: 227-232, 1987.
3. T. G. Habetler and D. M. Divan, "Control strategies for direct torque control using discrete pulse modulation", *IEEE Trans. Ind. Applicat.*, IA-27(5): 893-901, 1991.
4. M. T. Lamchich, "Contrôle direct de couple d'une machine asynchrone système de régulation de vitesse avec anti-emballement", Thèse de doctorat, Université Cadi-Ayyad, Marrakech. 2006.
5. Mondal, S.K.; J.O.P. Pinto, B.K.Bose, "A Neural-Network-Based Space-Vector PWM Controller for A three-Level Voltage-Fed Inverter Induction Motor Drive", *Industry Applications*, IEEE Transactions on. Vol 38, Issue 3, May/June 2002 Page(s):660 – 669.
6. O. Benaouda; A. Bendiabdellah, "la contribution du contrôle direct de couple d'une MAS alimentée par des onduleurs multi-niveaux en appliquant de l'intelligence artificielle (Logique Floue) ", seconde international Conférence on Power Electronics and Electrical Drives, ICPEED'12, Oran, Décembre 11-12-2012.

7. R. Toufouti «direct torque control for induction motor using intelligent techniques» Journal of Theoretical and Applied Information Technology JATIT, 2007.

